

LRS UK User Group



LRS[®]
OUTPUT MANAGEMENT

AGENDA

09:00 - 09:05 Introductions

Industry trends and LRS Product Update

- 09:05 - 10:05
- VPSX/OutputManager Cloud
 - VPSX updates
 - MFPsecure/Print and Scan

Guy Tucker &
Mark Ladd

- 10:05 - 10:35
- Future Product Roadmap
- Innovate Audit Cloud
 - Direct Print Cloud
 - Other possibilities

Guy Tucker &
Mark Ladd

10:35 - 10:50 Coffee Break

10:50 - 11:20 SAP Strategies & Documents, including Rise for SAP, BTP Connector, SAP Public Cloud and SAP Store

Chris Taylor

11:20 - 11:50 Customer Stories

Guy Tucker

11:50 - 12:20 Scan strategies

12:30 - 13:30 Lunch



Introductions



Industry Trends and LRS Product Update

What we are seeing in the industry?

- Office 365 enterprise licenses include Microsoft UP. What does that mean to an LRS user?
 - This appears to be a free addition for print. The prices have dropped since introduction
 - What are you seeing in your organizations?
- LRS perspective
 - What is a Microsoft UP certified printer?
 - What is a Microsoft UP print connector?
 - How does this fit with LRS printing?

Microsoft UP vs VPSX

- All users that print via UP must have an Azure ID and be licensed for it. This can be done via individual, but the better practice is to use Security groups.
- VPSX uses whatever security that you have.
- AD/Entra/LDAP/OIDC

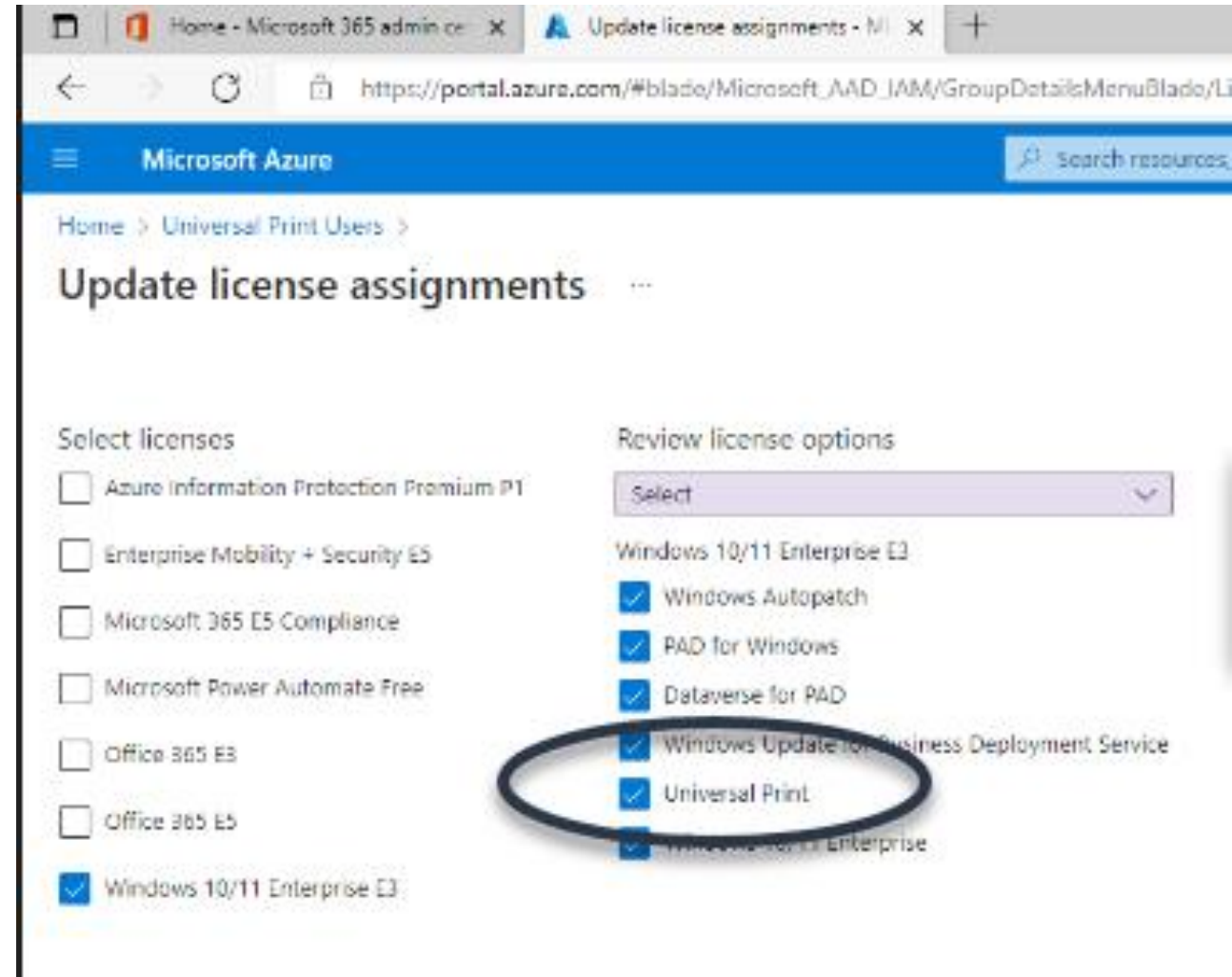

Microsoft UP vs VPSX

- Printers must be registered to UP. This appears to be done one at a time from the device or EWS
- VPSX handles deployment.
- Printers must then be assigned to users / groups in UP

The screenshot shows the Lexmark Embedded Web Server interface for a Lexmark C3224dw printer. The status is 'Ready' and the tray is low. The 'Network/Ports' section is expanded to show 'Universal Print' settings. The 'Registration' section shows the printer name 'Lexmark C3224dw' and a 'Register' button. Below the registration section, a verification code 'AVY723SAK' is displayed in a text box, with a 'Copy' button next to it. The code is circled in red. A blue callout box on the left contains the text: 'To complete registration, Allan needs to verify using the code provided. Select Copy.' Below the callout box are navigation buttons: 'Previous', '6/33', and 'Next'.

Lexmark Embedded Web Server

Lexmark C3224dw
IP Address : 192.168.1.19
Contact Name :
Location :

Status : **Ready**
Messages : **Tray 1 Low**

Select Option

- Status
- Settings
 - Device
 - Print
 - Paper
 - Network/Ports
 - Security
 - Reports
- Site Map

Network/Ports

- Network Overview
- Wireless
- Wi-Fi Direct
- AirPrint
- Ethernet
- TCP/IP
- SNMP
- IPSec
- 802.1x
- LPD Configuration
- HTTP/FTP Settings
- USB
- Restrict external network access
- Universal Print

Status

Device is not currently registered with Universal Print.

Registration

Printer Name: Lexmark C3224dw

Register

To complete the registration, please visit <https://www.microsoft.com/device/login> and enter the code below:

AVY723SAK Copy This code is valid for 15 minutes

To complete registration, Allan needs to verify using the code provided.
Select **Copy**.

Previous 6/33 Next

Microsoft UP vs. VPSX

- Printers / connectors always pull from UP
- VPSX can push to devices securely or jobs can be pulled via MFPsecure Internet Print facilities
- Microsoft UP prints jobs from macOS via an app, Mobile via OneDrive, Windows 11, and from Office 365
- VPSX prints from all these places as well as applications, other operating system platforms, and really anywhere.
- UP claims no drivers, but that's not exactly true.

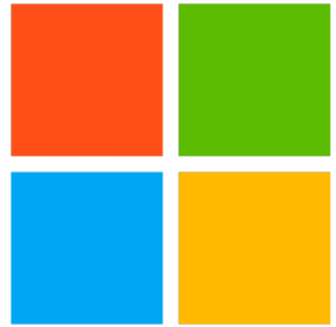

Microsoft 365

- Are you seeing questions around UP in your organization?
- Is Office 365 part of your daily work?



- How are you using AI?
- Do you see it in effecting the print arena?
- A few comments on LRS and AI



AI: Typical LRS use cases

- Predictive maintenance for hardware (MPS vendors)
- Rules-based routing of documents (automation)
- Analysis of audit data and trends – Mission Control and Azure Data Analytics
- Data Loss Detection / Prevention – identification and reporting of sensitive document content (print and scan)
 - LRS can provide function to capture & view print and scan to PageCenterX and/or send text-readable PDF to customer's AI system



Security

- Continued focus on zero trust, with increased use of 'internet only' and affiliate printing options by LRS customers
- Increase in penetration testing, compliance questionnaires (NIS2, etc) from LRS customers and partners
- Increased requirement for 'locked down' implementations

Infrastructure strategies

- Repatriation?
- On-prem, private Cloud?
- SaaS
- Hybrid model
- Containers



Requests for REST API

1. Simple method to submit print jobs and query job status
2. Install nothing on the remote client
 - Avoid administration to install / maintain LRSQ, Java API or IPP API on application server
 - Azure Functions use-case – no DLLs can be installed
 - Customer developed IPP client too complex
3. Secure
 - User Authentication
 - Encryption over network
 - User inclusion / exclusion lists?
 - File Type inclusion / exclusion lists?
4. Application Printing only
 - Use PPM or LRS Print App for user printing functions
 - Requires VPSX/Enterprise license for push print queues

Customer Security

Assumed Authorised traffic

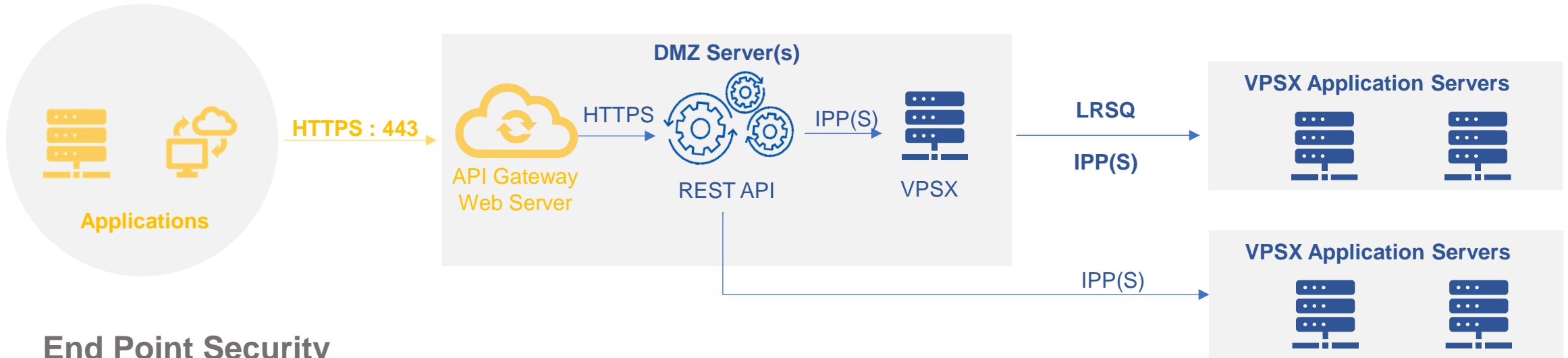

End Point Security

Controlled by API Gateway/Web Server by Customer

Options include

- Certificates
- OIDC
- Windows Auth
- Basic
- API Key
- None!

SubmitJob - POST

Body

```
{  
  "owner": "me@mydomain.com",  
  "fileName": "Interesting Test Print",  
  "vpsxPrinter": "ipp://simpleprint.mydomain.com:631/PRT001",  
  "printData": "SW50ZXJlc3RpbmVzZCBQcmludA==",  
  "jobAttributes": {"userData01": "some userdata", "userData02": "another value"}  
}
```

Parameter	Type	Description
Owner	String	Required owner of the print job
fileName	String	Document Name
vpsxPrinter	String	Uri of the desired VPSX Printer
printData	String	Base64 encoded print data
jobAttributes	JSON[]	JSON object of additional job attributes (optional)

SubmitJob - POST

Additional Job Attributes

Class	FormDef
Classification	Hold
Color	JobName
Copies	PageDef
Delegate	PageSize
Duplex	Title
Form	UserData01..16
Format	

SubmitJob - POST

JSON Response

```
{  
  "accepted": true,  
  "vpsxSpoolRef": "ipp://simpleprint.mydomain.com:631/PRT001/928968",  
  "globalID": "e15ac142-53f1-491b-aa11-7fc4feb12fcf",  
  "errorMsg": ""  
}
```

```
{  
  "accepted": false,  
  "vpsxSpoolRef": "",  
  "globalID": "",  
  "errorMsg": "Printer FW-EMEAh is not defined"  
}
```

```
{  
  "accepted": false,  
  "vpsxSpoolRef": "",  
  "globalID": "",  
  "errorMsg": "The input is not a valid Base-64 string"  
}
```

JobStatus - Get

Get Request

<https://<servername>/<AppFolder>/JobStatus?VPSXSpoolRef=<spoolref> &GlobalID=<global ID>>

Response

```
{
  "owner": "submitterName@mydomain.com",
  "fileName": "Test Print",
  "jobStatus": "Held",
  "created": "23:30:29 May/06/2024",
  "printed": "N/A",
  "error": ""
}
```

Document Bundling

- Many examples this year: healthcare, logistics, retail, etc
- Solutions based on either LRS Intelligent Document Bundling or Customer Scripts (professional services)



LRS Intelligent Document Bundling

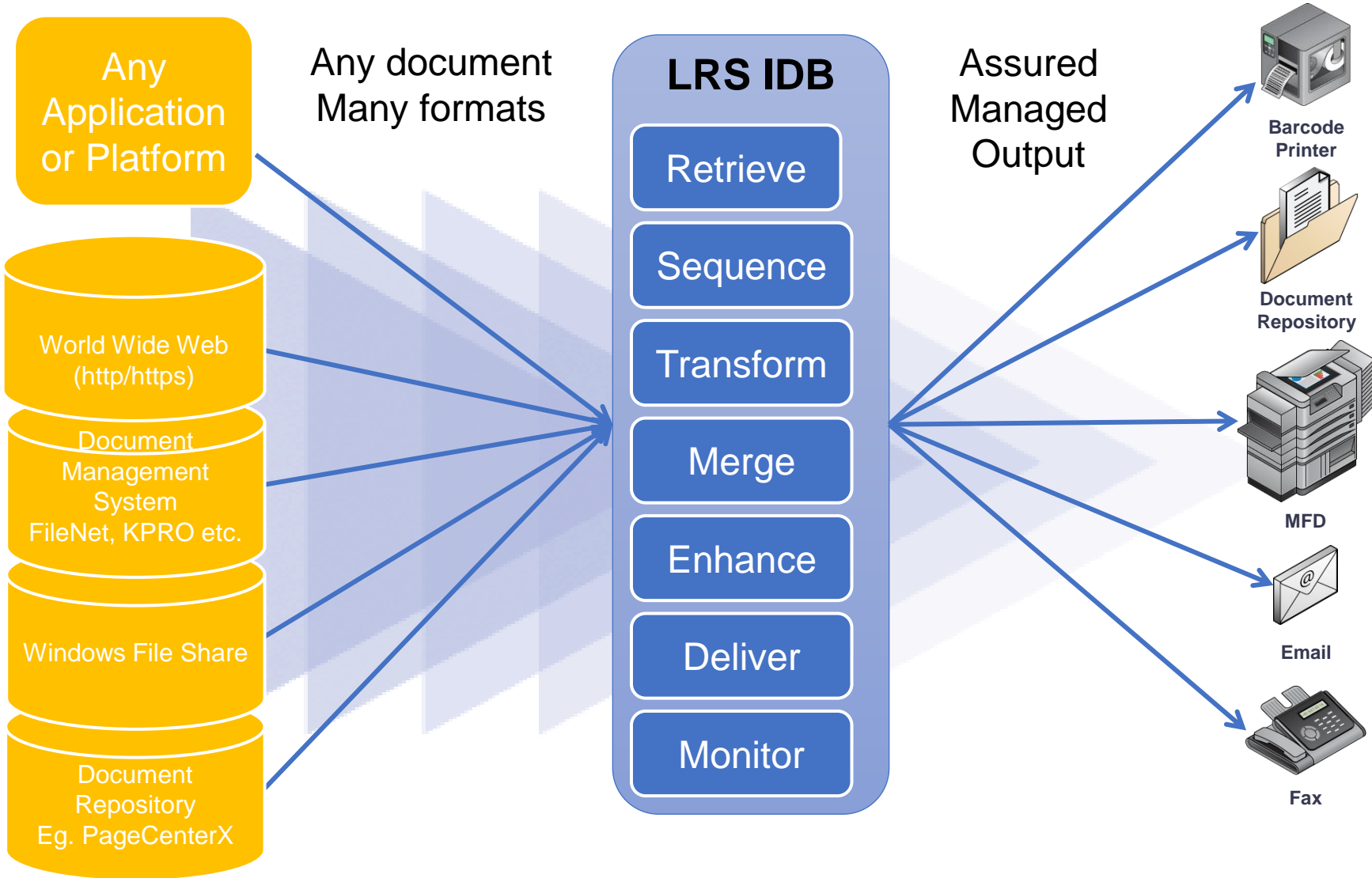

Masking

Printer	Location	Status	Printer Long Name	Queued	Retained	Printer Group	Properties
CH-POOL-QUEUE	1101	Idle	Chessington	2	0	CH_USER	
CH-PRT-01		Idle	0021B7FFB4B1 (Laser printer)	0	0	CH_USER	
CH-PRT-02		Idle	0021B7DF828E (Laser printer)	0	0	CH_USER	
CO-POOL-QUEUE	1121	Idle	Coatbridge	0	0	CO_USER	
CO-PRT-01		Idle	0021B7FF6CFB (Laser printer)	0	0	CO_USER	
CO-PRT-02		Idle	0021B7DF821F (Laser printer)	0	0	CO_USER	
CR-POOL-QUEUE	1102	Idle	Croydon	0	0	CR_USER	
CR-PRT-01		Idle	0021B7DF82F7 (Laser printer)	0	0	CR_USER	
CR-PRT-02		Idle	0021B7DF82B9 (Laser printer)	0	0	CR_USER	
EVENT_QUEUE_1101		Idle	Event queue for Chessington	0	0	CH_SYS	
EVENT_QUEUE_1102		Idle	Event queue for Croydon	0	0	CR_SYS	

- Printers
- PersonalQs
- MFPsecure
- Mobile Connector
- Innovate/Audit
- Print Server
- Gat Expand Administration options
- Security
- Web
- Apps

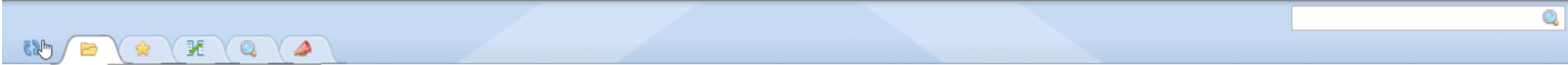

Current folder path: [root] / WAREHOUSES / CH / CONTROL / ROUTES / 23MAR21_2 /

Show: Folders/Documents

Locate: Document Go

File Advanced Add to Favorites Add Folder Upload Options

<input type="checkbox"/> Name	Warehouse	Route	Shift	Delivery Group	RunTime	Departure	Command	Regeneration	Status
(up one level)									
<input type="checkbox"/> ROUTE_051.CNTL	CH	051	2	2A	10:45	11:32		REGENERATION	Scheduled
<input type="checkbox"/> ROUTE_052.CNTL	CH	052	2	2A	10:10	11:30			Scheduled
<input type="checkbox"/> ROUTE_102.CNTL	CH	102	2	2B	10:35	11:30			Scheduled
<input type="checkbox"/> ROUTE_103.CNTL	CH	103	2	2B	10:35	11:30			Scheduled
<input type="checkbox"/> ROUTE_111.CNTL	CH	111	2	5A	11:10	11:30			Scheduled
<input type="checkbox"/> ROUTE_112.CNTL	CH	112	2	5A	11:10	11:30			Scheduled
<input type="checkbox"/> ROUTE_113.CNTL	CH	113	2	5A	11:10	11:30			Scheduled
<input type="checkbox"/> ROUTE_114.CNTL	CH	114	2	5A	11:10	11:30			Scheduled
<input type="checkbox"/> ROUTE_115.CNTL	CH	115	2	5A	11:10	11:30			Scheduled
<input type="checkbox"/> ROUTE_116.CNTL	CH	116	2	5A	11:10	11:30			Scheduled
<input type="checkbox"/> ROUTE_117.CNTL	CH	117	2	5A	11:10	11:30			Scheduled
<input type="checkbox"/> ROUTE_201.CNTL	CH	201	2	5B	11:37	12:30			Scheduled
<input type="checkbox"/> ROUTE_202.CNTL	CH	202	2	5B	11:37	12:30			Data ready
<input type="checkbox"/> ROUTE_203.CNTL	CH	203	2	5B	11:37	12:30		REGENERATION	Scheduled
<input type="checkbox"/> ROUTE_204.CNTL	CH	204	2	5B	11:37	12:30			Scheduled
<input type="checkbox"/> ROUTE_206.CNTL	CH	206	2	5C	11:52	13:00			Scheduled
<input type="checkbox"/> ROUTE_207.CNTL	CH	207	2	5C	11:52	13:00			Scheduled
<input type="checkbox"/> ROUTE_208.CNTL	CH	208	2	5C	11:52	13:00			Scheduled
<input type="checkbox"/> ROUTE_209.CNTL	CH	209	2	5C	11:52	13:00			Scheduled
<input type="checkbox"/> ROUTE_210.CNTL	CH	210	2	5C	11:52	13:00			Scheduled

Top of List View Next Selected: 0 Remember Selection



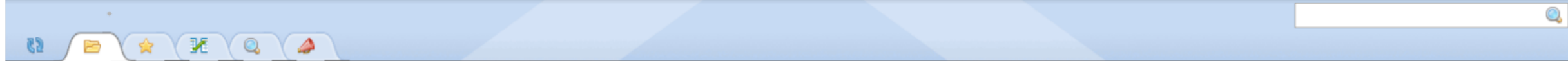

Current folder path: [root] / WAREHOUSES / CH / CONTROL / ROUTES / 23MAR21_2 /

Show: Folders/Documents

Locate: Document Go

File Advanced Add to Favorites Add Folder Upload Options

<input type="checkbox"/> Name	Warehouse	Route	Shift	Delivery Group	RunTime	Departure	Command	Regeneration	Status
(up one level)									
<input type="checkbox"/> ROUTE_051.CNTL	CH	051	2	2A	10:45	11:32	--		Printing Complete
<input type="checkbox"/> ROUTE_052.CNTL	CH	052	2	2A	10:10	11:30	--		Printing Complete
<input type="checkbox"/> ROUTE_102.CNTL	CH	102	2	2B	10:35	11:30	--		Printing Complete
<input type="checkbox"/> ROUTE_103.CNTL	CH	103	2	2B	10:35	11:30	--		Bundle Submitted
<input type="checkbox"/> ROUTE_111.CNTL	CH	111	2	5A	11:10	11:30	--		Bundle Submitted
<input type="checkbox"/> ROUTE_112.CNTL	CH	112	2	5A	11:10	11:30	--		Bundle Submitted
<input type="checkbox"/> ROUTE_113.CNTL	CH	113	2	5A	11:10	11:30	--		Bundle Submitted
<input type="checkbox"/> ROUTE_114.CNTL	CH	114	2	5A	11:10	11:30	--		Printing Complete
<input type="checkbox"/> ROUTE_115.CNTL	CH	115	2	5A	11:10	11:30	--		Bundle Submitted
<input type="checkbox"/> ROUTE_116.CNTL	CH	116	2	5A	11:10	11:30	--		Bundle Submitted
<input type="checkbox"/> ROUTE_117.CNTL	CH	117	2	5A	11:10	11:30	--		Bundle Submitted
<input type="checkbox"/> ROUTE_201.CNTL	CH	201	2	5B	11:37	12:30			Scheduled
<input type="checkbox"/> ROUTE_202.CNTL	CH	202	2	5B	11:37	12:30			Scheduled
<input type="checkbox"/> ROUTE_203.CNTL	CH	203	2	5B	11:37	12:30			Scheduled
<input type="checkbox"/> ROUTE_204.CNTL	CH	204	2	5B	11:37	12:30			Scheduled
<input type="checkbox"/> ROUTE_206.CNTL	CH	206	2	5C	11:52	13:00			Scheduled
<input type="checkbox"/> ROUTE_207.CNTL	CH	207	2	5C	11:52	13:00			Scheduled
<input type="checkbox"/> ROUTE_208.CNTL	CH	208	2	5C	11:52	13:00			Scheduled
<input type="checkbox"/> ROUTE_209.CNTL	CH	209	2	5C	11:52	13:00			Scheduled
<input type="checkbox"/> ROUTE_210.CNTL	CH	210	2	5C	11:52	13:00			Scheduled

Top of List View Next Selected: 0 Remember Selection



Printers

AH_CHESSINGTON

Output Queue (11)

Retained Queue (0)

Configure

Log

PersonalQs

MFPsecure

Mobile Connector

Innovate/Audit

Print Server

Gateway

Security

Web

Apps

● **AH_CHESSINGTON** MPVPS3
Idle - Not-Responding

Command ▾

Bulk Actions ▾

Queue Command ▾

Table Columns ▾

1 → 8 (11)

Job upload

Refresh

Pool ID	Bytes	Copies	Creation Time	Data Type	Pages	Filename	Job Status	Origin	Title
00106726	251150	1	2024/01/23 16:04:25	PCL	122	(CH) Bundled route 052	Held	API	Delivery
00106727	413787	1	2024/01/23 16:05:47	PCL	199	(CH) Bundled route 051	Held	API	Delivery
00106729	85956	1	2024/01/23 16:06:20	PCL	46	(CH) Bundled route 102	Held	API	Delivery
00106731	90341	1	2024/01/23 16:06:40	PCL	50	(CH) Bundled route 114	Held	API	Delivery
00106733	59797	1	2024/01/23 16:06:55	PCL	33	(CH) Bundled route 103	Held	API	Delivery
00106736	101325	1	2024/01/23 16:06:58	PCL	56	(CH) Bundled route 111	Held	API	Delivery
00106738	114425	1	2024/01/23 16:07:02	PCL	58	(CH) Bundled route 112	Held	API	Delivery
00106739	94116	1	2024/01/23 16:07:05	PCL	52	(CH) Bundled route 115	Held	API	Delivery



LRS Support Site

Find the answers you need when you need them

 **OPEN A SUPPORT CASE**
Request Support

 **MAINTENANCE REQUEST**
Request Maintenance

 **KNOWLEDGE BASE**
Browse and Search for Articles

Announcements

Testing the portal announcement ▼

My Recent Cases

Maintenance Request - 2023-06-05
CS0073068 • about an hour ago

VPSX case
CS0073067 • about an hour ago

Needs Attention

No records found



Service Now

LRS Knowledge Base

Find the answers you need when you need them

Search (minimum 3 characters)



Pre Recs & Checklists

More information here.



FAQs

More information here.



Release Notes

More information here.



Best Practices

More information here.



Product Documentation

Documentation, Training, End of Support, etc.



Tech Tips

How to make the most from your LRS Software

Service Now

Refine results

Knowledge Bases

Release Notes

Category

> Release Notes

Products





- DMCF
- DRS
- IDB for VPSX
- Innovate/Audit
- Innovate/Mill
- LRS
- LRS Transforms
- LRS/MVS Server
- LRS/NET

Last Modified

- Past 2 Years
- Past Year
- Past Month

135 Results Sort by | Views **Newest** ▾ Alphabetical

Applied Filters Release Notes

-  **MFPsecure V1 R4.0 fix 0011 - Applied 09/19/24**
Release Notes > Open Systems > MFPsecure
Note: Customers using the HP Agent and upgrading to MFPsecure 1.3.54 or later must upgrade the HP Agent to V1R3.054.005 immediately following the MFPsecure upgrade. Redeployment is not required. HP devices will require...
KB0010490 • 10d ago • 25 Views
-  **LRS Transforms and Innovate Mill V1 R4.0 fix 0011 - Applied 09/16/24**
Release Notes > Open Systems > Transform
New distribution of Conversion_1 Version 202409 (refer to con1chglog.txt for detail).
KB0010488 • 10d ago • 6 Views
-  **LRS Transforms and Innovate Mill V1 R3.0 fix 0023 - Applied 09/16/24**
Release Notes > Open Systems > Transform
New distribution of Conversion_1 Version 202409 (refer to con1chglog.txt for detail).
KB0010487 • 10d ago • 2 Views
-  **LRS/Web Connect V1 R4.0 Fix 0002 - Applied 09/03/24**
Release Notes > Open Systems > VPSX
Enhancement: Added support for VPSX Print app to communicate via application/x-www-form-urlencoded.
KB0010485 • 20d ago • 6 Views
-  **Innovate/Audit V1 R4.0 Fix 0006 - Applied 09/03/24**
Release Notes > Open Systems > VPSX
Enhancement: New keyword DATAREKEY has been introduced to indicate when AuditX should process all data files at...

Service Now

Product updates - VPSX

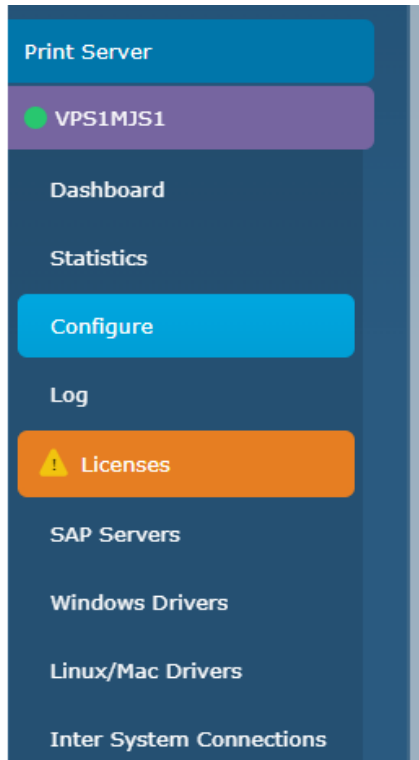

Print Server

VPS1MJS1

Dashboard

Statistics

Configure

Log

Licenses

SAP Servers

Windows Drivers

Linux/Mac Drivers

Inter System Connections

* Access point

hw10764.lrsinc.org

This is the address of the access point in the load balancer or cluster. It can either be the hostname or the fully qualified domain name.

* This Node

hw10764.lrsinc.org

This is the address of the node in the load balancer or cluster. It can either be the hostname or the fully qualified domain name.

* Other Nodes

These are the addresses of the other nodes in the load balancer that this server needs to interact with. A node can either be a hostname or a fully qualified domain name.

hw07068

lrseoma3

Product updates

HA / Parallel processing Awareness

Clients like PPM and the VPSX Print App can retrieve job information across all VPSX nodes Today

Product Updates - VPSX

Options

Only detect data type of binary files
Ignore spool file separator attribute
Do not pass events to external command
Process FORMAT attribute for all jobs
Ignore PageCopies attribute in PCL6

- Send jobs regardless of device status
- Do not increment retry interval
- Disable remote print server status feedback
- Do not process jobs until all printers are active
- Treat all document delivery errors as retryable conditions

Job retries are enhanced

Product Updates - VPSX

This is the address of the access point in the load balancer or cluster. It can either be the hostname or the fully qualified domain name.



* This Node

eomepicr3.lrsinc.org

This is the address of the node in the load balancer or cluster. It can either be the hostname or the fully qualified domain name.



* Other Nodes

These are the addresses of the other nodes in the load balancer that this server needs to interact with. A node can either be a hostname or a fully qualified domain name.

Remove

Add



Process jobs from all nodes

A static list of five other VPSX nodes was allowed before. That list has been increased to 10, and the UI allows for addition of these without the static list.

Product Updates - PPM

- Added support for Windows ARM64 platform
 - Note – Drivers are not necessarily ARM compatible – VPSX differentiation?
- Added a CO₂ based cost enhancement to the Policy enforcement
- More control over printer naming in PPM

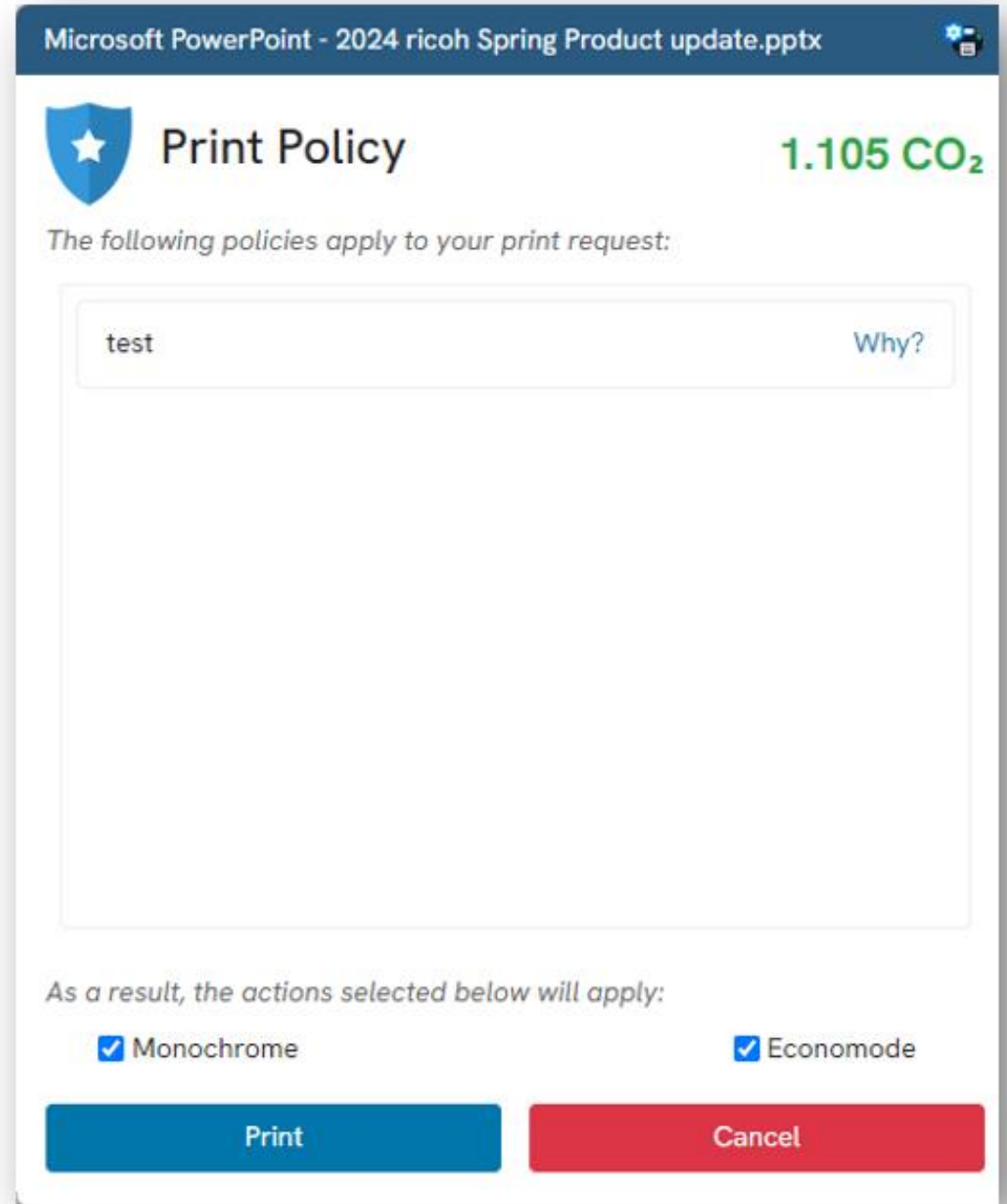

Product Updates - MFPsecure

- Improved device-based accounting dependability
- Added Internet only print and scan to Konica Minolta agent
- Added support for MFP authentication code expiration
 - This required updates in PPM and LRS/Gateway
- Added support for advanced printer options at release time (force mono/duplex) for Ricoh agent
 - This allows for making changes at the device

VPSX/OutputManager Cloud

- We have long had VPSX/OutputManager
- We now have VPSX/OutputManager Cloud as well

BTP-PRINT-OMS - S/4HC-PUB-PRINT-OMS ACCESS METHOD Q (S/4HC-PRINT-OMS)

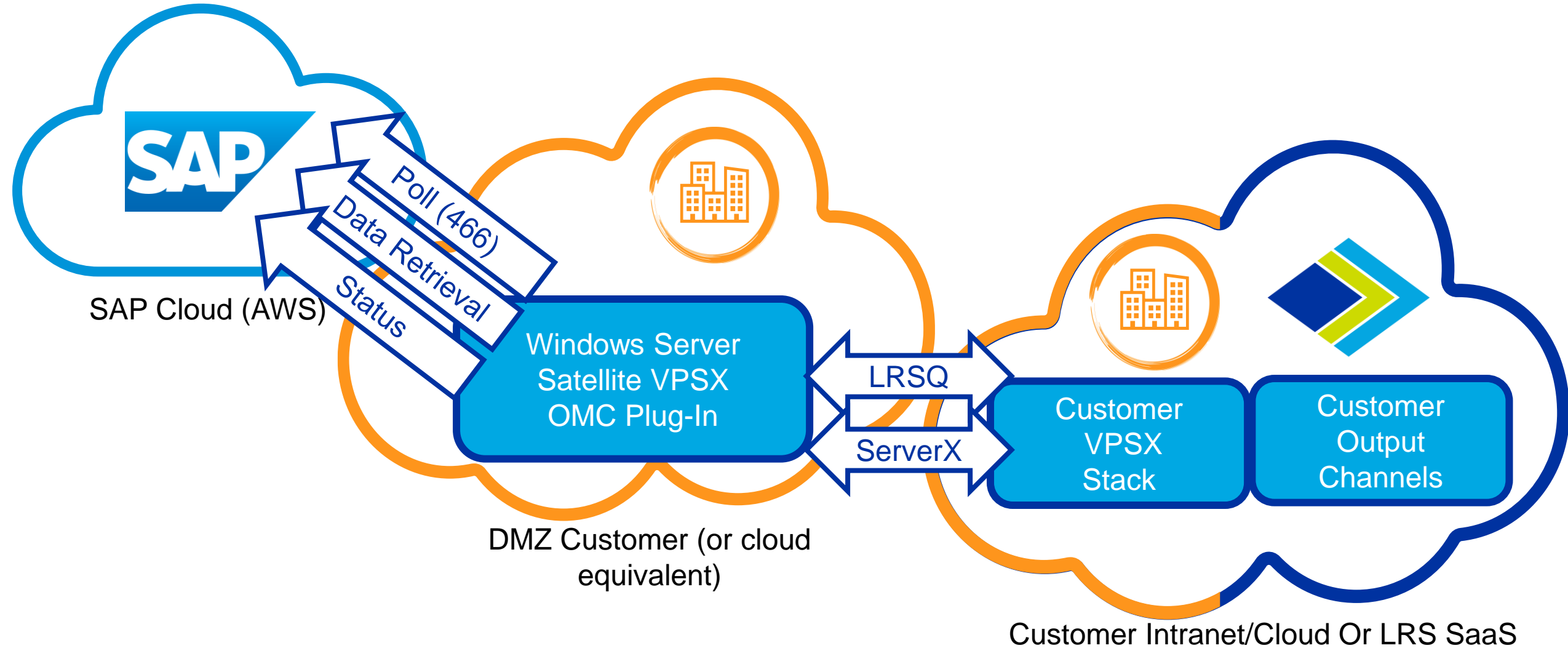

Product Updates - MFPsecure

- Updated the Scan UI to make functions available from the main VPSX UI
- Most functions are included with more being added with each release
 - Profiles
 - Previews
- A few are not
 - Bates stamping

Add Profile

Device Demo

Profiles Data sources User Manager Advanced

Profiles

Sort Filter + Add

Disabled



Copy of File



Not supported by VPSX Admin App



AddressBook



File



ScnToMyEmail



Product Updates - MFPsecure



Scan UI

Cool new things in the UI

- Ability to test functions directly from the web interface
- Page segmentation for enhanced document analysis
- Option to only show profiles to non-logged in users

Things not in the new UI

- Input Types currently not in UI
 - Built In List Fields
 - SharePoint Managed Metadata
 - Advanced Folder Search
- Processing Types currently not in UI
 - Zonal OCR
 - Bates Stamping
 - Watermarking
 - Page Numbering

SharePoint Delegate Permission Req

To use Delegated Permissions for Secure Scan the following additional requirements need to be met:

- Must be running the below versions or newer
 - Secure Scan 14.8 or newer
 - Gateway V1R4.0.005 or newer
- Must be using LRS/Gateway as the authentication mechanism
- Clients/Service accounts must opt-in using Personal Print Manager (PPM)
- Data Source is created in Web Interface under Gateway and not the Secure Scan UI

Azure App Permissions

Graph API Permissions Required

- User.Read
- Group.Read.All

SharePoint API Permissions Required

- AllSites.FullControl
- Sites.Search.All
- TermStore.Read.All

Gateway

Configure

Log

LRS Mission Control

Profile Rules

Logins

Apps

PPM Brokers

App Registration EOM Apps App Integration

Search Add Options Refresh

Name	Application ID
------	----------------

App Integration

Name: SP365CP

Integration Type: Microsoft

Graph API

SharePoint

Default User: nick@

Scopes: https://lrscloudprint.sharepoint.com/.default

Client ID:

Tenant ID:

Save Cancel

Adding the App to Gateway

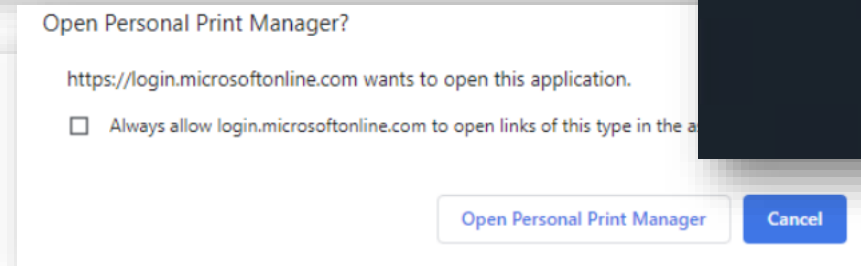
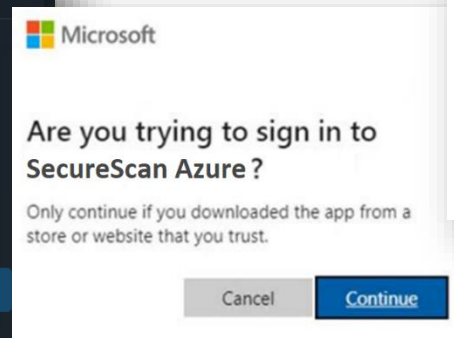
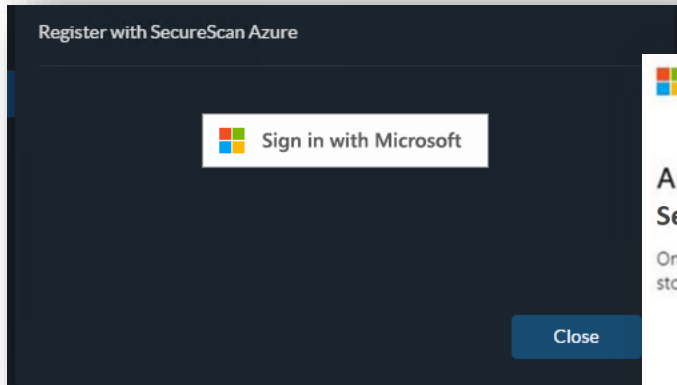
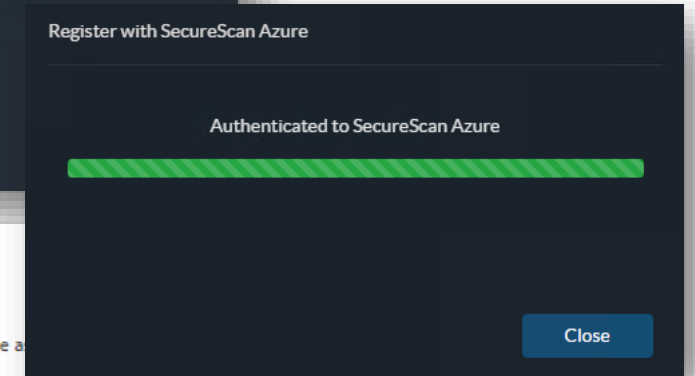
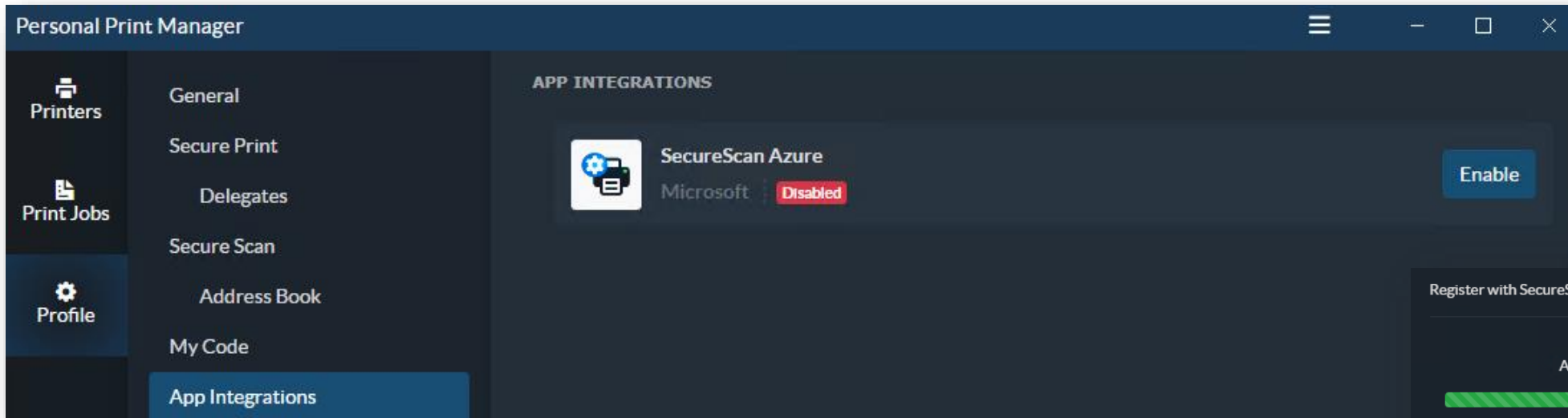

End User Authorization - PPM

Input - SharePoint Folder Selection

Folder Selection

Connection Check permission

Site ...

Library Documents

Root 

Use logged on user

Usage – Used to allow the end-user at the device to browse and scan from the device. When enabled it will automatically configure the SharePoint Output field to match.

Input - SharePoint Managed Metadata

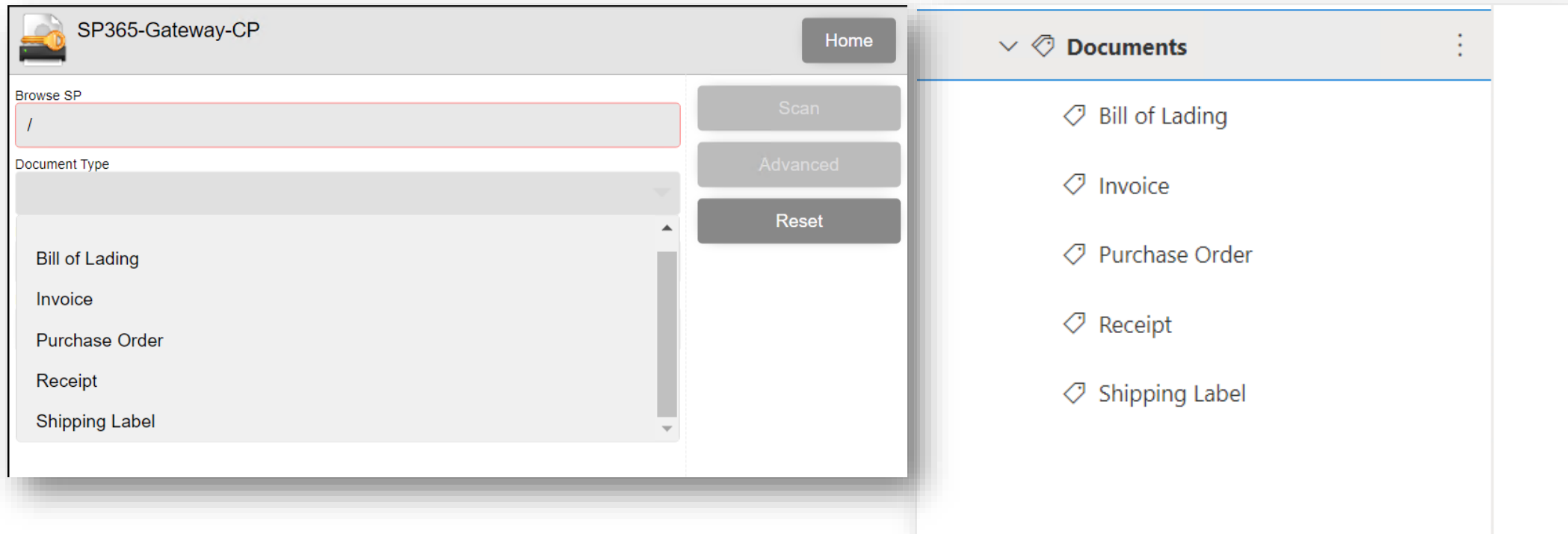

Usage – Allows the user to select from list of entries pulled directly from SharePoint's Termset.

Requirements – SharePoint Folder Selection must be enabled, and the SharePoint Site must have a managed metadata field configured.

Index data

Document library Accounts Payable

Secure Scan field	SharePoint field
PO#	Purchase Order Number
Total	Amount
OrderedBy	Ordered By
INVDate	Document Date
Filename Output	
DocumentType	Document Type
Scan Device	Scan Device
Invoice	Document Number
Sequential number (GUID)	
Barcode (Document Separation)	Amount
FullPage	Description
	Document Date
	Document Number
	Document Type
	Ordered By
	Purchase Order Number
	Scan Device

Accounts Payable

Name	Modified...	Docume...	Docume...	Purchase...	Docume...	Scan Dev...	Ordered By	Amount	Modified
INV#151804 P0...	Nick Bennett	Invoice	151804	24891	2/19/1999	HP DEMO	Joanna	\$17.40	4 hours ago
INV#171615 P0#19841 on ...	Nick Bennett	Invoice	171615	19841	2/19/1999	HP DEMO	Milton Waddams	\$35.00	4 hours ago
INV#55555 P0#123456 on ...	Nick Bennett	Invoice	55555	123456	7/25/2008	HP DEMO	Derrick Huff	\$999.99	4 hours ago
INV#55555 P0#654321 on ...	Nick Bennett	Invoice	55555	654321	11/16/1981	HP DEMO	Tommy Tutone	\$86,753.09	4 hours ago

Output – SharePoint Metadata Mapping



Futures

Innovate Audit Cloud

- Innovate Audit – What is the cost to print?
 - Requires SQL Server
 - Included with the cost of many LRS products
 - Requires setup and ongoing DBA support
 - Updates done by the admin
- Innovate Audit Cloud – What is the cost to print?
 - Data is moved to Mission Control
 - Cost is based on usage / storage
 - SaaS – So updates are done automatically
- Both will continue to be supported and enhanced by LRS

Reporting in the Cloud

1542

Total Pages

3.78K

Total Impressions

3.99K

Total Cost

171.04

Possible Savings

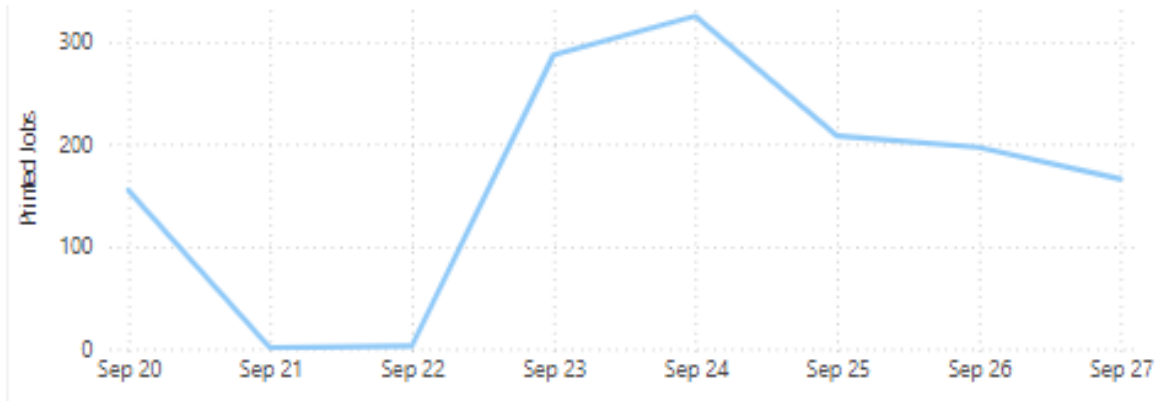
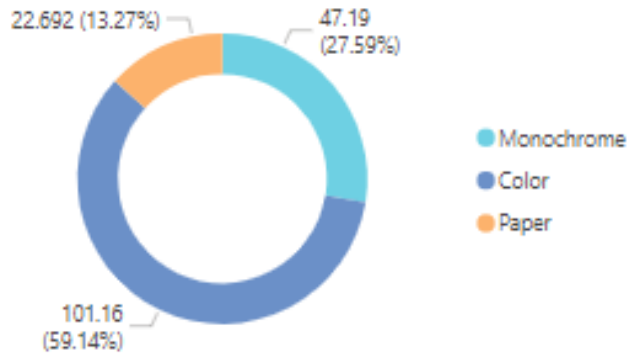

Top Printers by Print Volume

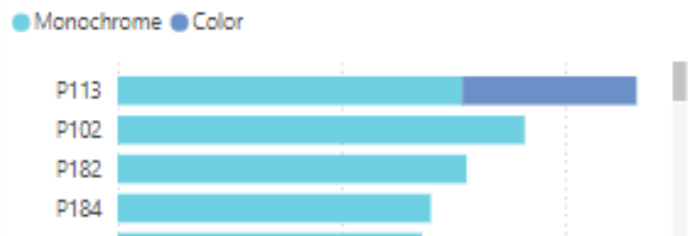

Top Departments by Cost



Driven by Power BI

Some new dashboarding not currently in the onsite version

Custom reports must be done by LRS

9/1/2024

9/27/2024

Last 7 Days

This Month

This Year

Custom

481.86
Energy Cost (kWh)

164.79
CO2 Cost (kg)

0.10
Trees Saved with Duplexing

859
Pages Saved with Duplexing

0.00
Trees Saved from Expired Jobs

0
Pages Saved from Expired Jobs

Energy Consumption Cost



CO2 Cost



Top Departments by Environmental Impact

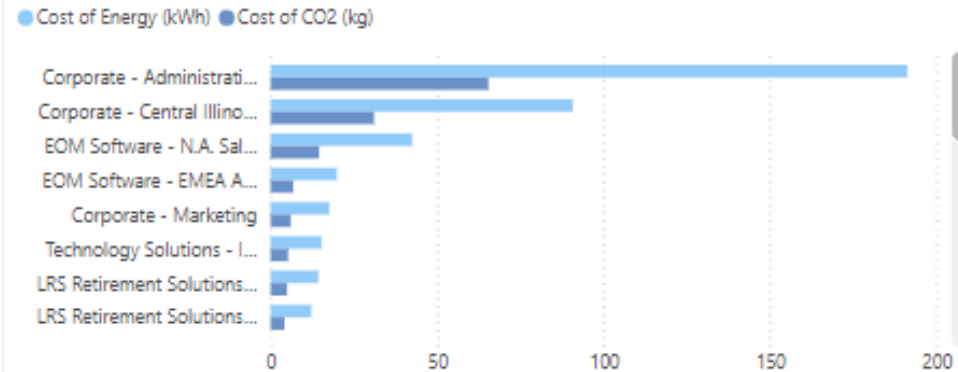

Top Printers by Paper Utilization

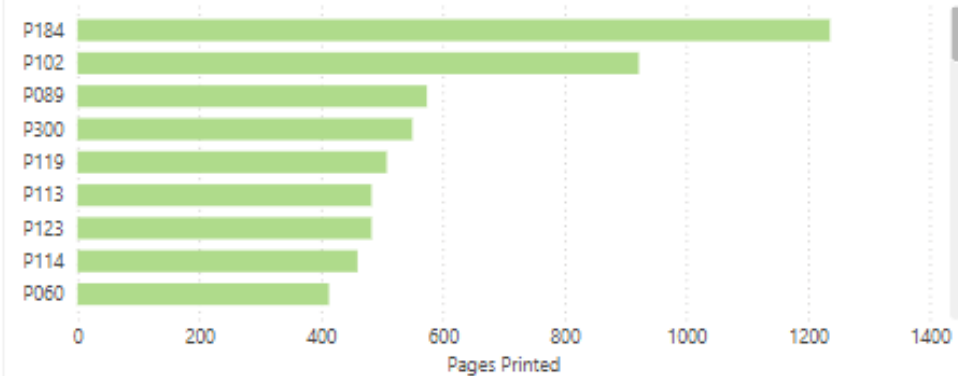

Innovate Audit Cloud

9/20/2024

9/27/2024

Last 7 Days

This Month

This Year

Custom



Printed Jobs



Simplex Jobs

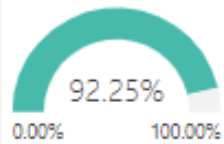

Color Jobs

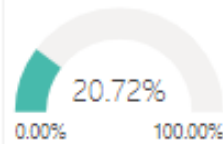

Processed Job Types



- Print Server
- Print Direct
- Print DBA
- Copy
- Copy DBA
- Scan DBA
- Fax DBA

Jobs by Origin



Possible Savings

88.52

Mono Enforcement Savings

7.74

Duplex Enforcement Savings

Top Printers	Printed Jobs	Simplex Jobs	Color Jobs	Total Impressions
P113	116	116	39	158
P102	91	91		222
P182	78	78		105
P184	70	70		601
P087	68	68		98
P300	60	58	51	174
P123	57	57		68
P101	55	45		110
Total	1302	1200	271	3888

Top Departments by Print Volume



Top Printers by Ink and Paper Usage

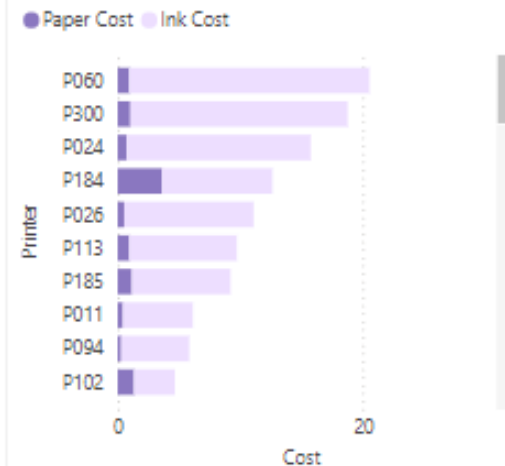

Print Volume

Start Date 09/20/2024

End Date 09/27/2024

Source Unknown, Print Server, Pri

Location

View report



Location Summary

All Jobs: 1000 Impressions: 2638 Pages: 2479 Cost: \$109.68

Sources: Unknown, Print Server, Print Direct, Print - DBA, Copy, Copy - DBA, Scan, Scan - DBA, Fax - DBA, Other

Location	Mono	Color	Total	Pages	Job Cost
United Kingdom/Gloucestershire/Cheltenham	27	77	104	102	\$10.26
United States/Illinois/Springfield/Building 5/Level 0	0	14	14	14	\$1.76
United States/Illinois/Springfield/Building 5/Level 1	1	0	1	1	\$0.02
United States/Illinois/Springfield/Building 5/Level 2	1019	95	1114	1054	\$33.01
United States/Illinois/Springfield/Building 6/Level 0	481	47	528	525	\$16.01
United States/Illinois/Springfield/Building 6/Level 2	7	2	9	9	\$0.40
United States/Illinois/Springfield/Building 7	184	103	287	242	\$16.57
United States/Illinois/Springfield/Building 9/Level 3	42	60	102	102	\$8.44
United States/Illinois/Springfield/Building 9/Level 4	351	128	479	430	\$23.21

Many reports the same as onsite

Innovate Audit

- We have added some to the new Cloud offering soon to be released
- But in the end, we continue to support both onsite and Cloud
 - That is our philosophy as a whole - To run your environment where and how you want.

Direct Print SaaS

- Coming later this calendar year or early next year
- Again, a parallel offering. Direct Print will continue to be enhanced in the current onsite / Private cloud offering
- SaaS is strictly an option to those that see this as a benefit

The basic idea

- We have had requests for a serverless environment – no VPSX anywhere
- This is a response to this.
- PPM remains the client, but the functions of VPSX operate in the SaaS client
 - Driver management
 - Printer selection and deployment
 - Security authentication mechanism (LRS/Gateway)



LRS Mission Control

Customers

Levi, Ray & Shoup, Inc.

Dashboard

EOM Environment

Licenses

My Reports

Notifications

Security

Activity Log

My Profile

Admin

Levi, Ray & Shoup, Inc.

Customers > EOM Environment > Demo Env

Overview

Print Server

Desktop App

Audit

Print Jobs

The last 30 days of printing



Latest Activity

A snapshot of the most recent activity

 **Printer Added**
07/30/2024 09:27:07 AM





 **Printer Rule Updated**
07/30/2024 09:27:07 AM

 **Print Job Printed**
07/30/2024 09:27:07 AM

Just a view of the UI

Manage

Administrator options for items associated with Personal Print Manager

-  Download Personal Print Manager >
-  Add Printer Rule >
-  Add Policy >
-  Add Bootstrap Token >

Current Deployments

Information about what is currently installed

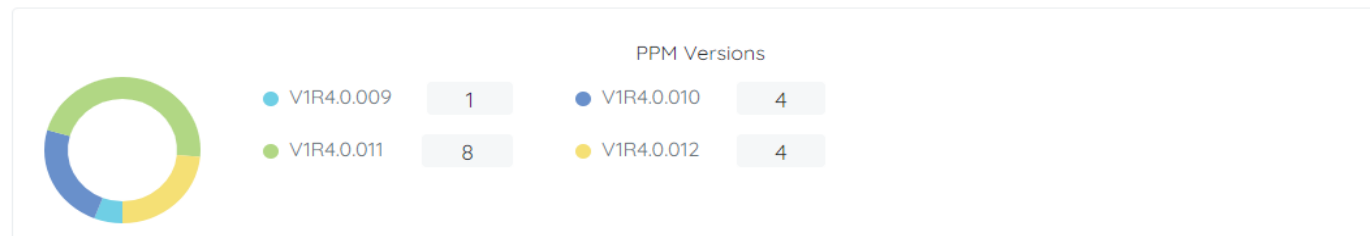
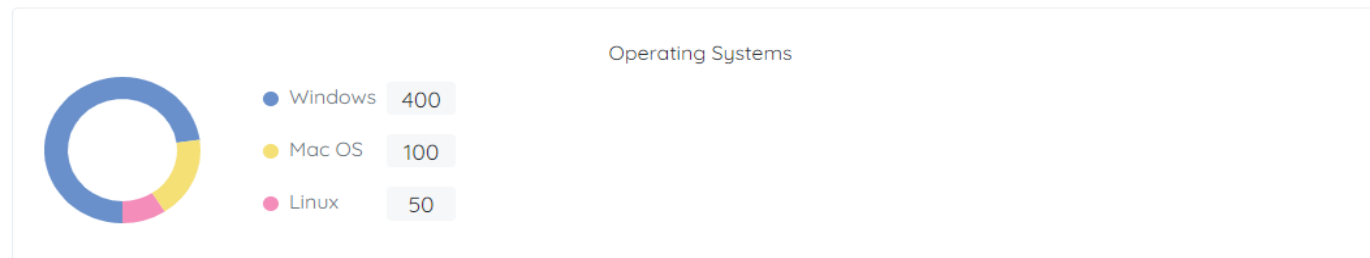

Another View

LRS UK User Group Coffee Break



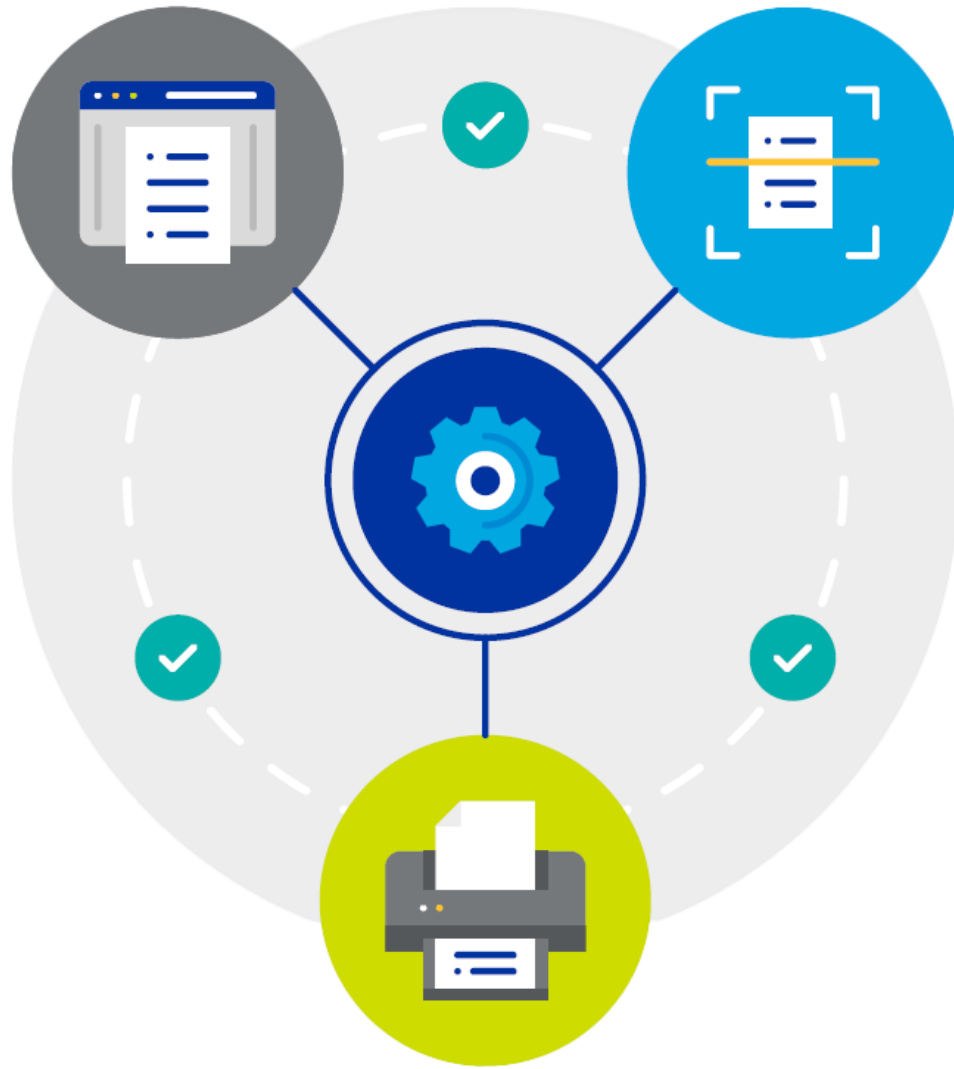

SAP Strategies and Documents

Print Problems

rapidly become

Business Problems

when we're talking about documents which drive core business processes.





Document Issues



IT Challenges



Business Changes



SAP Feedback



Specialized SAP Knowledge



Security & Reporting

SAP S/4HANA Migration Considerations



Brownfield Upgrade ECC 6

Migration possible but with printing challenges and operational overheads

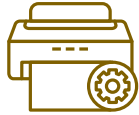

Brownfield Upgrade ECC 6

with an existing Output Management platform



Greenfield SAP S/4HANA

Standardization of global business processes with new functionality



Bluefield SAP S/4HANA

Migrates proven components while replacing obsolete ones

Requirement:

Print from any SAP Application, on-premise, private cloud, or hybrid

ECC6

SAP S/4HANA

- Cloud Private Edition
- On Premise
- Public Cloud

SAP Business Technology Platform

- SAP Print Service
- SAP Digital Manufacturing

To any printer, label device or output destination

SAP Print and Scan Complexity

Print Interface Challenges

- Native printing will require use of Windows Print Servers
 - Security issue
 - Not scalable
 - No HA
- Print definitions must be managed by BASIS team
- Time consuming and resource intensive to resolve print issues



Works with RISE with SAP

Integrations with and extensions to SAP digital core that qualify as 'Works with RISE with SAP'

RISE with SAP

S/4HANA Private Cloud

Customer Challenge

- Migrate to S/4HANA using the “RISE with SAP” program
- Eliminate the use of VPN’s rely on Public Internet only
- Future-proof SAP S/4HANA Private Cloud update support
- Simplify global support (reduce SAP BASIS team reliance)

Technical Requirements

- Simplify infrastructure and reduce cost for printing architecture
- Replace:
 - Proprietary uncertified SAP output management system
 - Document automation, bundling and conversion tool.

RISE with SAP Customer Story

- Secure, assured print originating from SAP S/4HANA (Linux on AWS) with LRS Output Management
- Removal of 125 Windows Print Servers
- Removal of 2x incumbent Output Management Tools and supporting infrastructure
- Future proof printing capabilities including:
 - Authenticated secure release
 - A fully managed Service for all SAP and Workplace printing in 2025-26



Print Interface Challenges

- **No Flexibility:** Cannot adapt to specific infrastructure designs.
- **Inability to Use Pull Print:** Limited printing options.
- **Poor Scalability:** Not suitable for growing needs.
- **No Finishing Options:** Lacks advanced printing features.
- **No Assured Delivery:** Unreliable delivery of print jobs.
- **No Accurate Feedback:** Limited feedback on print job status.
- **Deployment Requirements:** Requires redeployment or existing Windows Print Servers.
- **Local Management:** SAP Cloud Print Manager needed at each physical location.

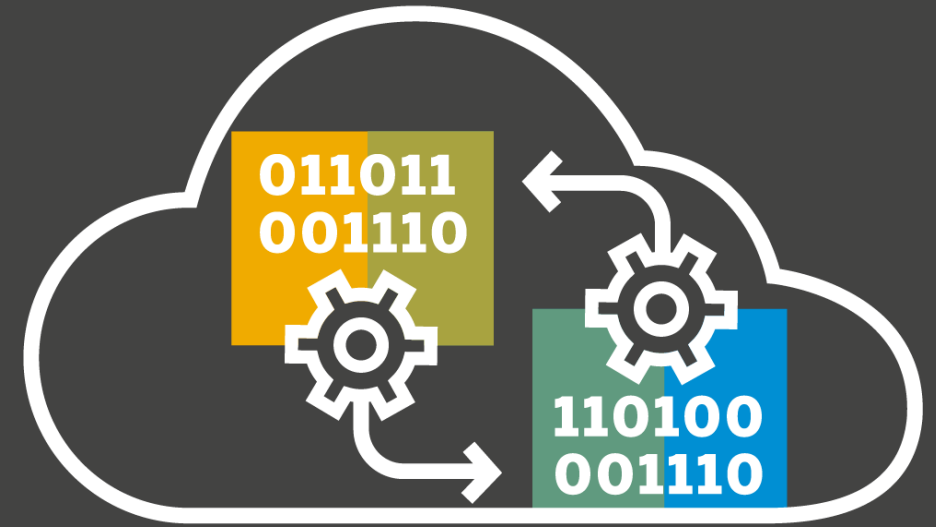

SAP Business Technology Platform

With SAP BTP, you can efficiently build or extend SAP Solutions

SAP Business Technology Platform including SAP Digital Manufacturing

Customer Challenge

- Remove Intranet by January 2024
- All sites will become Zero Trust sites
- SaaS ready solutions are preferred due to agility

Technical Requirements

- No device will be connected within local network. Clients and printers are internet only clients
- Backend printing needs a S/4HANA certified Print solution which interfaces with existing EUC secure print solution

New Architecture

- Printing via public Internet; no expensive VPN's, leased lines or fees to service provider
- Standard architecture for all backend application
- S/4HANA certified and therefore meets business requirements (S/4HANA certified solutions only)
- Can be managed externally as a service



Print Interface Challenges

- **Lack of Flexibility:** Cannot adapt to specific infrastructure designs.
- **No Pull Print Capability:** Limited printing options.
- **Scalability Issues:** Poor scalability for growing needs.
- **No Finishing Options:** Lacks advanced printing features.
- **Unreliable Delivery:** No guaranteed delivery of print jobs.
- **Inaccurate Feedback:** Limited feedback on print job status.
- **Deployment Requirements:** Requires redeployment or existing Windows Print Servers.
- **Local Management:** SAP Cloud Print Manager needed at each physical location.



**SAP Public Cloud
Edition**

Ready-to-run cloud ERP

SAP Public Cloud Solutions

Customer Challenge

- A digital transformation project required integration with SAP Public Cloud
- Interoperate with existing EUC secure print solution

Technical Requirements

- Pass owner information to the existing pull print solution.
- Achieve High Availability by utilizing existing infrastructure.

New Architecture

- Integration between SAP Public Cloud with Xerox Workplace Pull Print, ensuring uninterrupted printing and correct ownership of prints in SAP PROD and QA environment.
- Print without delays or errors, optimizing workflows and saving time
- Quick implementation minimized downtime and avoided revenue losses
- Enhanced security protects critical information from unauthorized access
- Flexible infrastructure adaptable to expanding operations and additional systems



Our SAP Partnership



**Certified for SAP
output interfaces
from BTP to BC-XOM
and works with
RISE with SAP**

SAP[®] Certified
Integration with Cloud Solutions

SAP[®] Certified
Integration with SAP S/4HANA[®]



Available on
SAP Store

A Customer story from across the pond



Scan Strategies

Features at a Glance

Image Processing

- Image Cleanup
- Blank Page Deletion
- Barcode Reading
- Zonal OCR
- OCR (Optical Character Recognition)
- Document Separation – Batch Scanning

User Experience and Management

- Single Sign On Support
- Profiles Based on Logged In User
- Auto Name and Route Documents
- Consistent Look on a Wide Variety of MFPs

Integration & Lookup

- Database Lookup
- Index Documents Directly at the MFP
- Ability to kick off 3rd party applications and APIs

Three Main Reasons



Centralized
Management



User Scanning

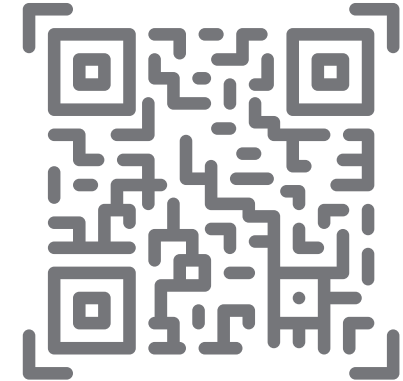

Workflow Scanning

Centralized Management

- Single Pane of Glass with VPSX/MFPSecure
- Same look and feel across many device types
- Set Service Account Globally or Per Profile
- PPM Personal Contact List



Centralized Management – Use Case

Customer Challenge:

- Fleet of 1000+ devices with multiple scan-to-network folder destinations
- Service account password changes every 90 days
- IT spends a week updating passwords on all devices
- Jobs sent to \\localserver\username based on device location

Solution with Secure Scan:

- Created a profile with conditional logic to determine the server based on MFD location
- Eliminated the need for thousands of profiles/destinations
- Secure Scan allows global service account updates, reducing password update time from a week to a few minutes

Two Types of Scanning

User Scanning

- E-mail
- OneDrive
- Teams
- Google Drive
- Fax

Workflow Scanning

- Invoices
- Packing Slips
- Sharepoint
- Document Management Systems
- Processes that can be automated with Barcodes, Zonal OCR
- Expenses
- Connecting to 3rd party apps



Secure Scan
Select a scan profile

Scan to Email

Scan to Home Folder

Scan to OneDrive

Send a Fax

Stay in profile

User Scanning

User Scanning – Single Sign On



- Show Profiles Based on User/Groups
- Email added to Users' Sent items (O365, Exchange, Google Apps)
- Browse & Scan to Home Folder, OneDrive, Teams, Google Drive, Box
- Access personal contact list for Email/Fax from the MFD
- Query LOB applications/APIs with permissions
- Office 365 supports Delegate and Application Permissions

Single Sign On with Office 365

Application-Only Permissions:

- Allows acting as the user without user opt-in
- Global Administrator grants Azure application access to all users
- SecureScan connects using a client-secret

Delegated User Permissions:

- Requires user opt-in via PPM for Azure Application login
- Users grant App registration access to their profile
- Users need to re-grant permissions if the token is revoked or expires

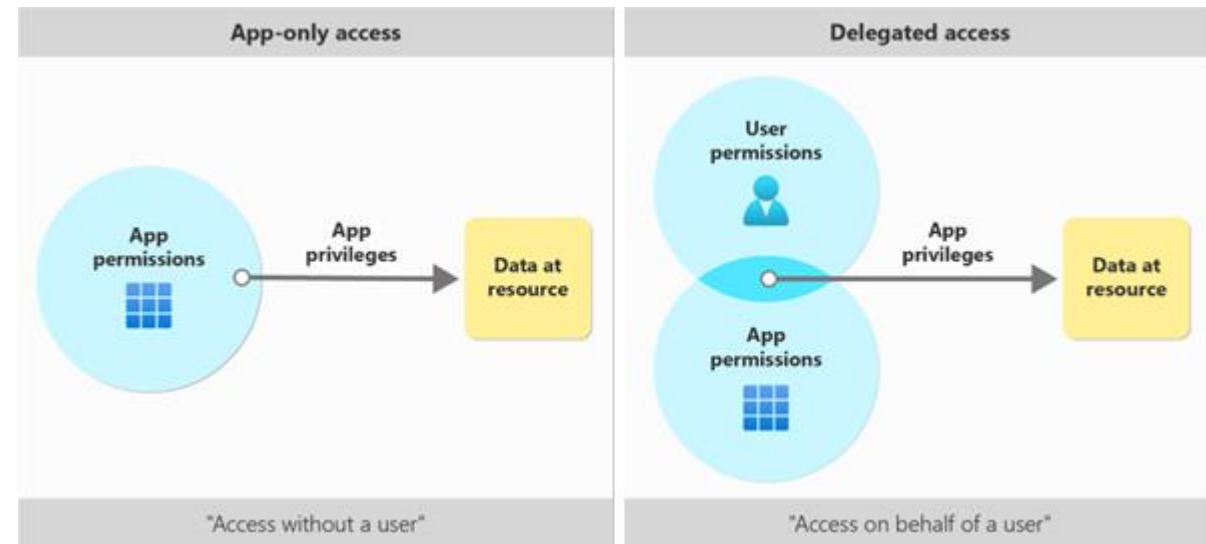

Delegate Permissions – SSO

Register with SecureScan Azure

Sign in with Microsoft

Microsoft

Permissions requested

SecureScan Azure
[App info](#)

This application is not published by Microsoft.

This app would like to:

- ✓ Maintain access to data you have given it access to
- ✓ Sign you in and read your profile
- ✓ Have full access to all files you have access to

Accepting these permissions means that you allow this app to use your data as specified in their terms of service and privacy statement. You can change these permissions at <https://myapps.microsoft.com>.

Important: Only accept if you trust the publisher and if you downloaded this app from a store or website you trust. Ask your admin if you're not sure. Microsoft is not involved in licensing this app to you.

Does this app look suspicious? [Report it here](#)

Cancel Accept

Register with SecureScan Azure

Authenticated to SecureScan Azure

Close

Print Jobs

Delegates



Secure Scan

Address Book

My Code

App Integrations

APP INTEGRATIONS

	MFPSecureDelegate Microsoft	Enabled
	SP365CP Microsoft	Enabled

User Scanning – SSO E-mail

Scan To Email
Nick.Bennett@lrs.com

Home Exit

Copy to Self

Scan

Filename
Optional - If left blank a default

Advanced

Select E-mail Recipients

TO

CC

BCC

PPM Personal Address Book

Add to Personal Address Book?

Contact Name
Optional - Only used when adding to contacts

Reset

Subject
Optional / If left blank a default subject will be used

Body
Optional

Convert to
PDF

Logged in User shown in Description field

Check Box to do Copy to Self

Nick

Bennett, Nick - Nick.Bennett@lrs.com

Funky Fresh - nick.bennett@lrs.com

Billy Bob Joe - nick@drivve.com

Happy Gilmore - nick.bennett@lrs.com

Convert to

PDF

PDF

PDF (searchable)

No conversion

User Scanning – Folder & Cloud Storage

OneDrive
Browse Folders and Scan to OneDrive

Home

Browse OneDrive
/

New Folder
Create a new folder/subfolder

Filename
Optional - If left blank a default filename will be used

Convert to
PDF

Scan

Advanced

Reset

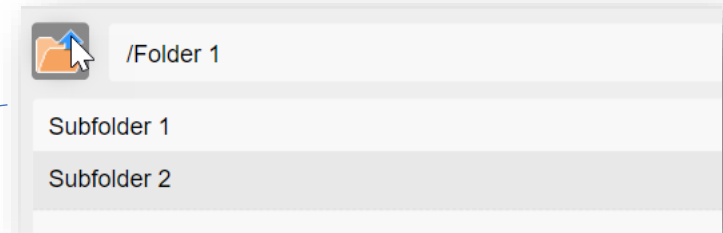

Create new folders on the FLY!

Convert to

PDF

- PDF
- PDF (searchable)
- No conversion

User Scanning - Fax

 Scan to Fax Server [Home](#)

Read Me
Only manually enter fax numbers that do not exist in your contacts

PPM Fax Contacts [Scan](#)

Recipient Number [Advanced](#)

Manual Entry of Fax Number [Reset](#)

Recipient Name

Manual Entry

Add to Personal Address Book?

PPM Fax Contacts

Nick - 867-5309

recipient name

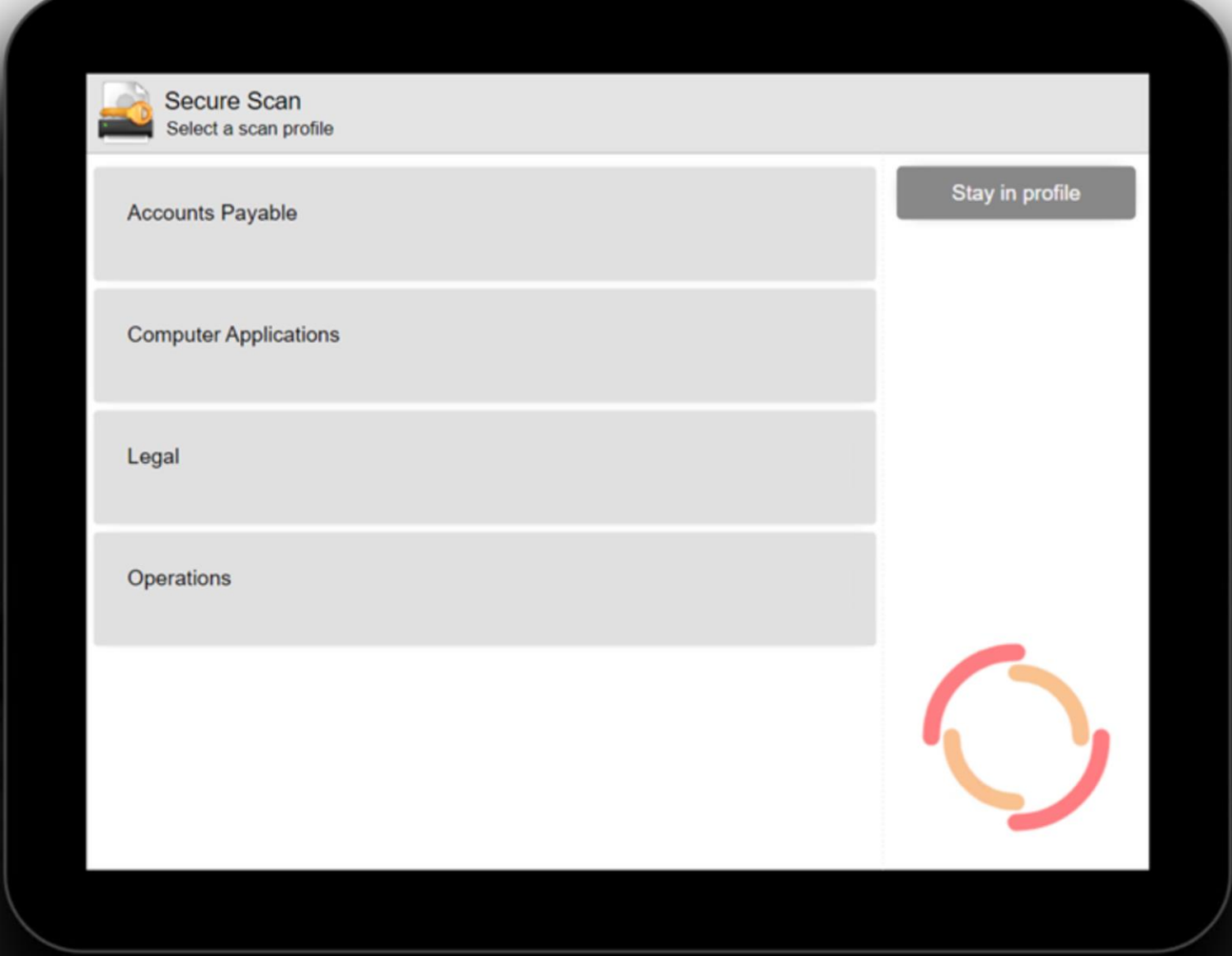

Workflow Scanning

Workflow – 3 Simple Scanning Steps

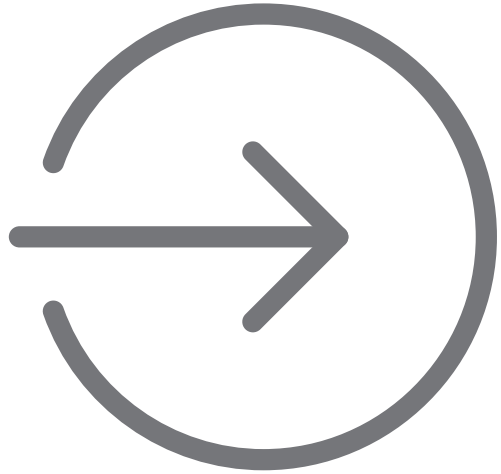

INPUT

(Capture from MFP or Mobile Device)

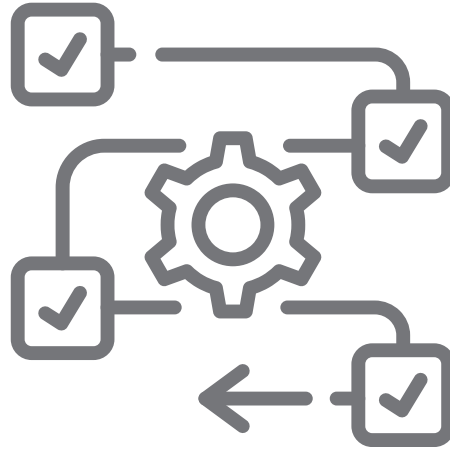

PROCESSING

(Barcodes, Zonal OCR, Etc)

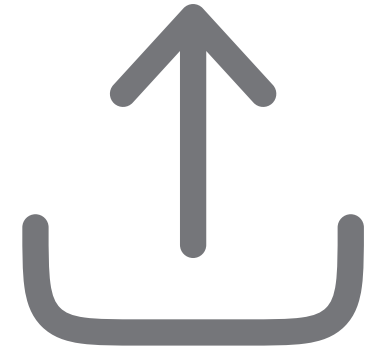

OUTPUT

(Automatic Document Routing)

Input Fields

- List Fields
 - Static
- ODBC Queries
 - Dynamic
 - Existing Data
- Searchable Folder Fields
- Make Fields Mandatory

The screenshot displays two panels from a software application. The top panel, titled 'Computer Applications SP', features a 'Content Type' dropdown menu with options: 'Computer Application Document', 'Comp Doc 2', and 'Comp Doc 3'. To the right of this panel are three buttons: 'Scan', 'Advanced', and 'Reset'. The bottom panel, titled 'ODBC Lookup', has the subtitle 'Look up from Customer's Datasource'. It includes a search input field with a magnifying glass icon and a list of results: 'AROUT - Around the Horn', 'BSBEV - B's Beverages', 'CONSH - Consolidated Holdings', 'DRIVV - Drive LLC', 'EASTC - Eastern Connection', 'GREAL - Great Lakes Food Market', 'HUNGC - Hungry Coyote Import Store', 'ISLAT - Island Trading', 'LAZYK - Lazy K Kountry Store', and 'LETSS - Let's Stop N Shop'. A vertical scrollbar is visible on the right side of the list. Both panels have a 'Home' button in the top right corner. The bottom panel also has an 'Ok' button on the right side.

Processing

- Bates Numbering
 - Watermarking
 - Page Numbering
- Separate Documents
- Barcode Recognition

- Zonal OCR

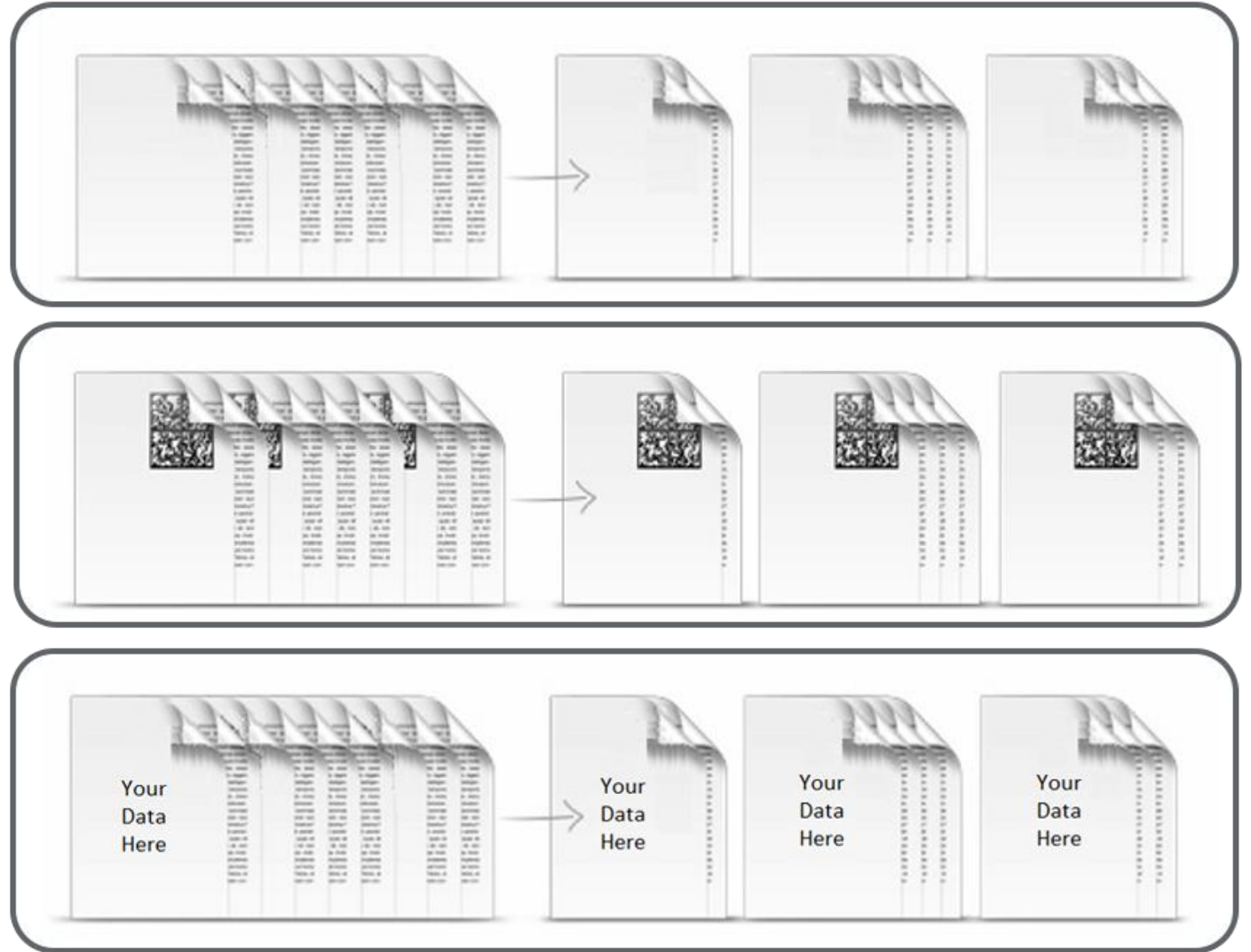



Scan to Expense Report

Home

Report Name

Expense Date

3/18/2024

Expense Vendor

Expense Amount

Convert to

PDF

Scan

Advanced

Reset

Scan to Expense Reports



SP365-Gateway-CP

Browse SP

/

Document Type

Bill of Lading

Invoice

Purchase Order

Receipt

Shipping Label

Index data

Document library Accounts Payable

Secure Scan field	SharePoint field
PO#	Purchase Order Number
Total	Amount
OrderedBy	Ordered By
INVDate	Document Date
Filename Output	
DocumentType	Document Type
Scan Device	Scan Device

+ New | Upload | Edit in grid view | Sync | Add shortcut to OneDrive | Pin to Quick access | All Documents

Accounts Payable

Name	Modified	Docume...	Docume...	Purchase...	Docume...	Scan Dev...	Ordered By	Amount
INV#151804 P0#24891 on ...	Nick Bennett	Invoice	151804	24891	2/19/1999	HP DEMO	Joanna	\$17.40
INV#171615 P0#19841 on ...	Nick Bennett	Invoice	171615	19841	2/19/1999	HP DEMO	Milton Waddams	\$35.00
INV#55555 P0#123456 on ...	Nick Bennett	Invoice	55555	123456	7/25/2008	HP DEMO	Derrick Huff	\$999.99
INV#55555 P0#654321 on ...	Nick Bennett	Invoice	55555	654321	11/16/1981	HP DEMO	Tommy Tutone	\$86,753.

Scan to Sharepoint

Scanning to PageCenterX

Customer Challenge:

- Customer wanted to keep a copy of all scanned documents sent by each user. No matter what profile the end-user selected

Solution with Secure Scan:

- Secure Scan sends to multiple output destinations simultaneously
- Profiles automatically send a copy of scanned jobs to PageCenterX
- Files are dynamically organized under <username>/<profile name> for easy navigation and auditing

User Scanning | Workflow Scanning | Audit Scanning

Connecting to 3rd Party Applications

Input:

- Universal Datasource for searching and selecting results at the device.

Processing:

- Pass user-entered data, barcodes, zonal OCR, etc., to third-party applications/scripts.
- Results returned to Secure Scan.

Output:

Trigger scripts/apps after file drop in a temporary folder.

Additional Support:

- WebDav
- ODBC



Example – US Law Enforcement

Customer Drivers

- Multiple form types and destinations
- Customized Authentication
- Non-technical end-user expectations
- Large scan jobs
- OCR optimization

Chosen Solution

- MFPsecure Scan Pro
- Scan to Folder
- Scan to Sharepoint

Example Workflows

Common Values:

1. Unique ID
2. Category Code
3. Time
4. Organization Identifier

- Incident Reports (IRP) Uniform Reporting Number (URN) format

- ##-#####-####-###.tif
||----- 2 digit
| |----- 5 digit
| |----- 4 digit
| |----- 3 digit

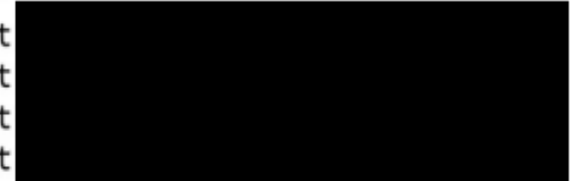

- Booking Package (BP) Booking Number (BKG) format

- ##-#####-##-###.tif
||----- 2 digit
| |----- 7 digit
| |----- 2 digit
| |----- 3 digit

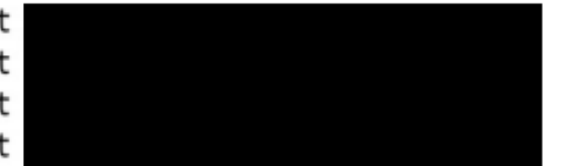

- Both Detective Station and Detective Specialized Uniform Reporting Number (URN) format

- ##-#####-####-D###.tif
||----- 2 digit
| |----- 5 digit
| |----- 4 digit
|----- MUST INCLUDE prefix {D|d}
| |----- 3 digit



Example - Financial Organisation

Customer Drivers

- Consolidate Applications to One Supplier
- Retaining Functionality of existing solutions
- Provide innovation

Chosen Solution

- MFPsecure/Scan PRO

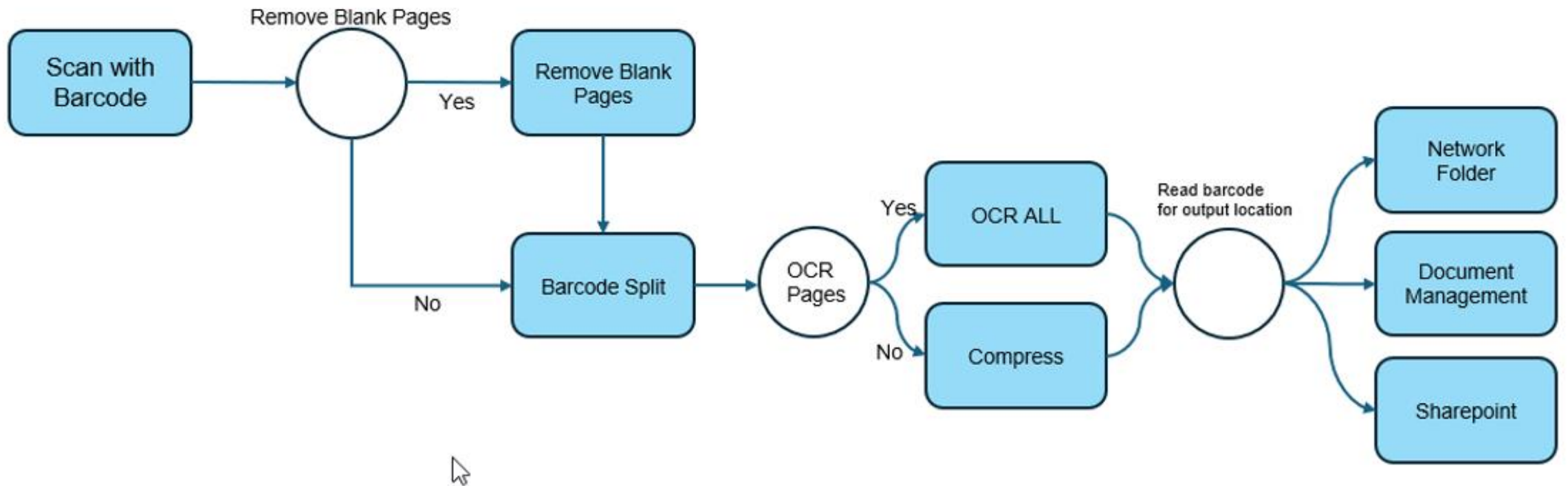

Solution Implemented



Questions?

LRS UK User Group Q&A



LRS UK User Group Lunch

